

3/8" HOLES FOR WEIGHT

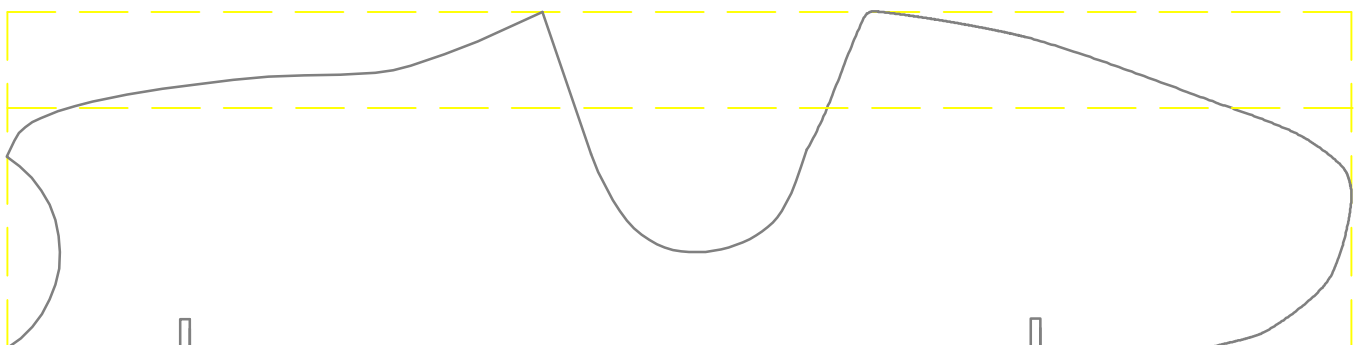

LOCOMOTIVE 873  
POWERED BY PACK #12

GLUE EXTRA WOOD TO BLOCK FOR REQUIRED HEIGHT



GLUE EXTRA WOOD TO BLOCK FOR REQUIRED HEIGHT

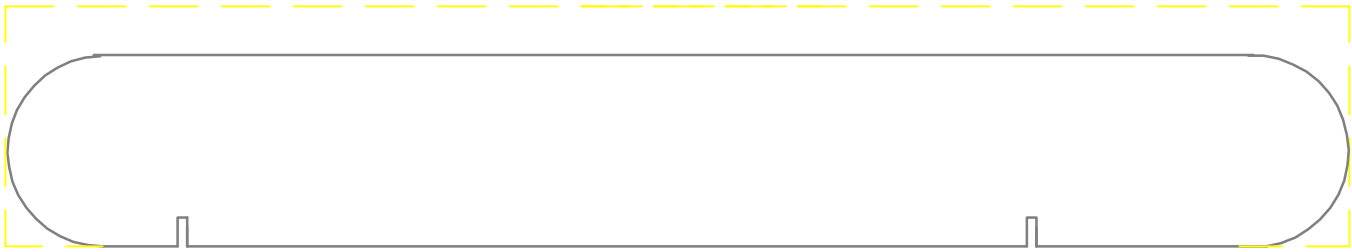
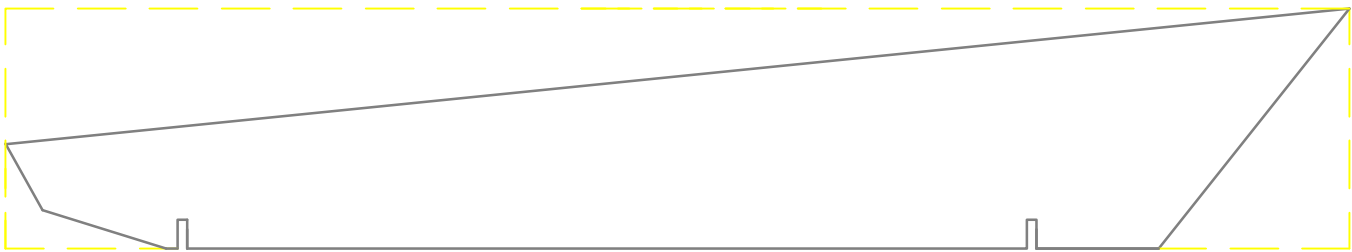
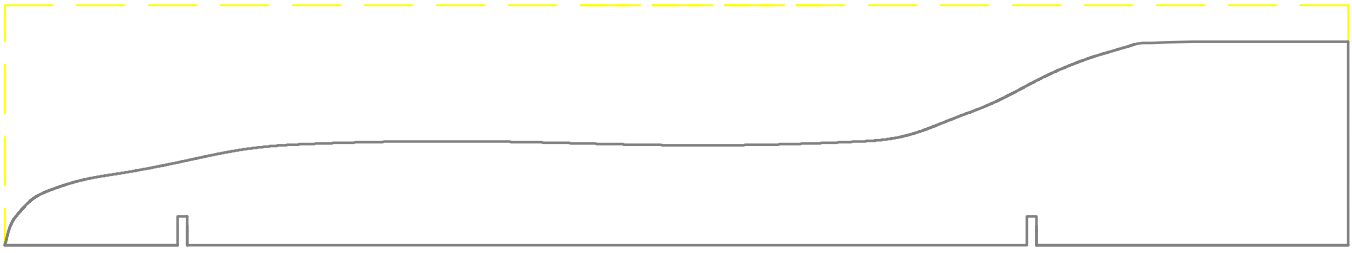

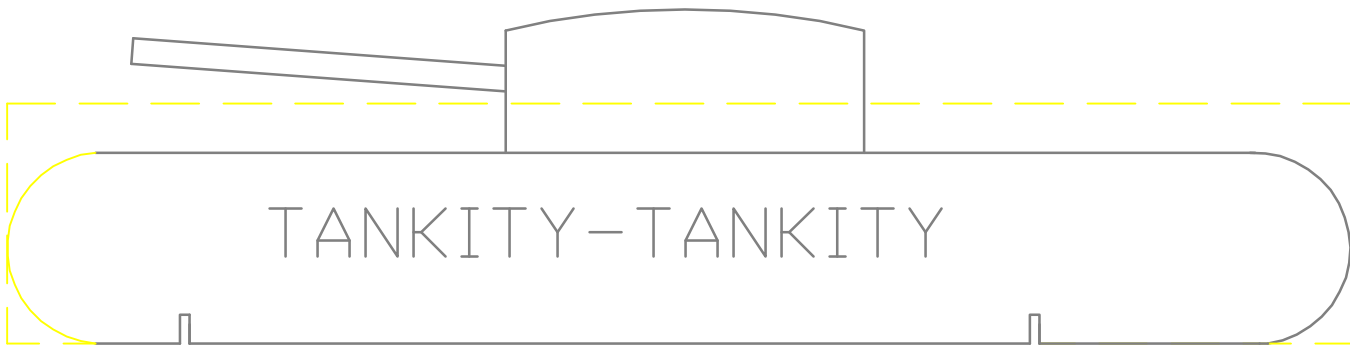

ADD WOOD FOR TURRET AND BARREL

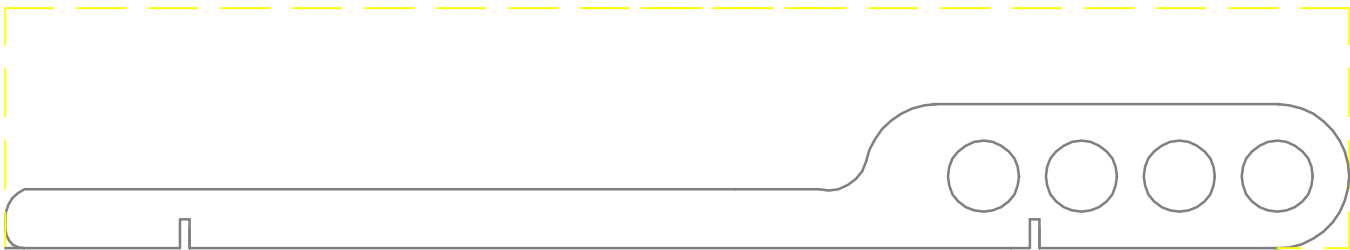

ADD WEIGHT IN 3/8" HOLES

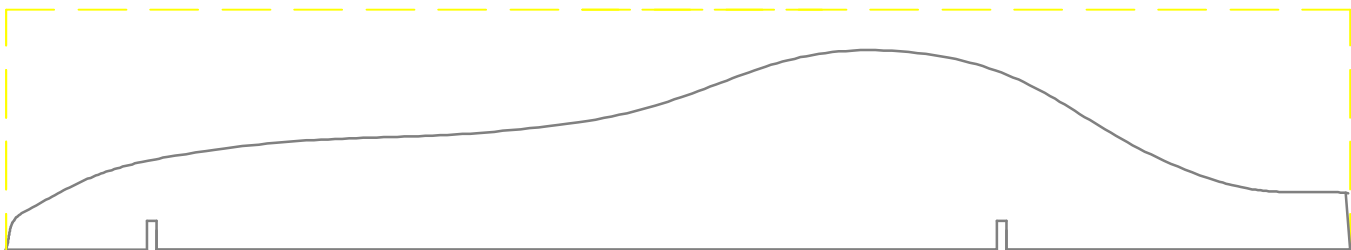

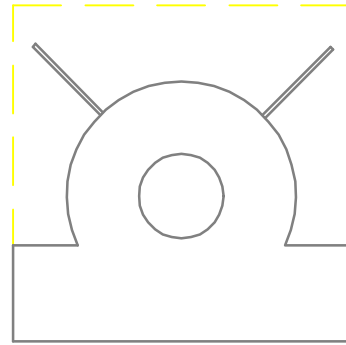
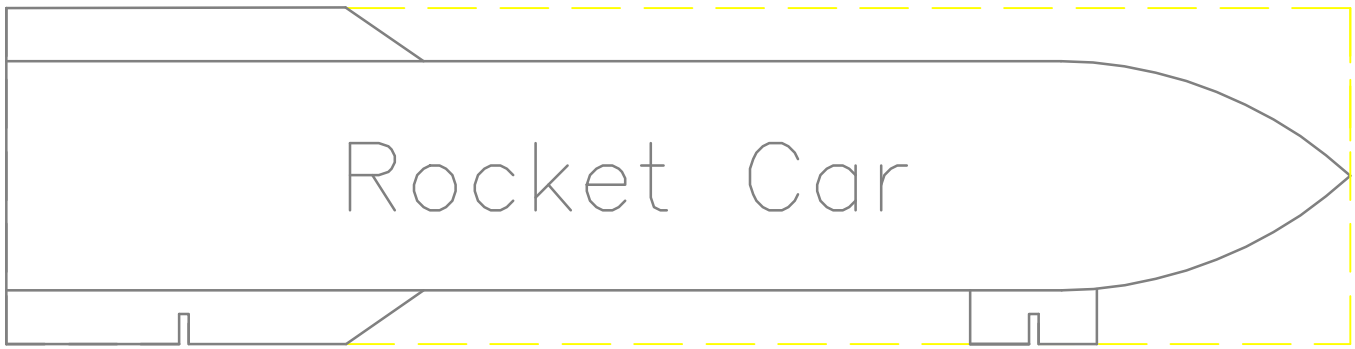

END VIEW

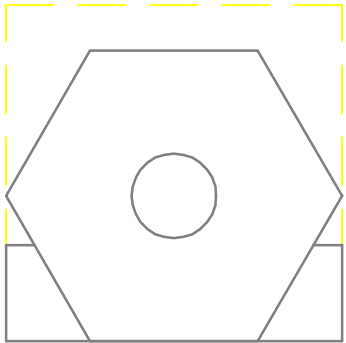

END VIEW

GLUE ADDITIONAL WOOD FOR THESE DESIGNS

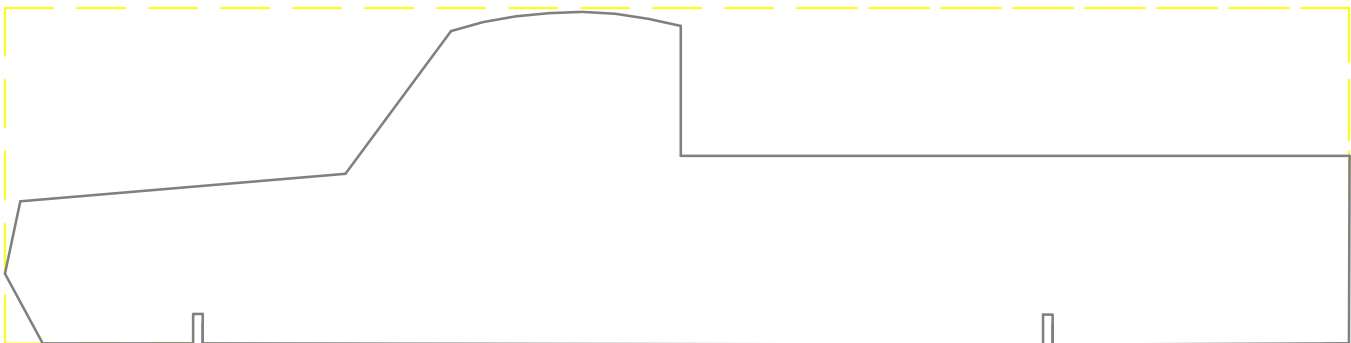
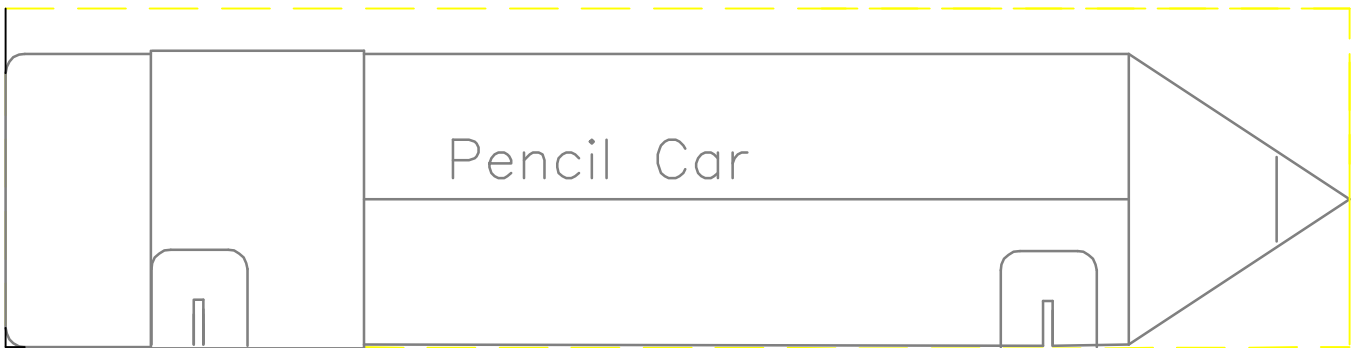

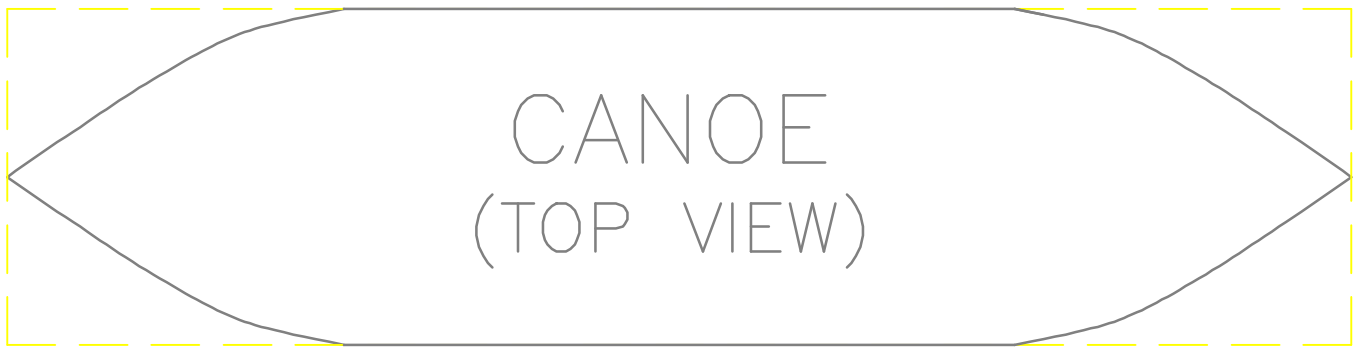
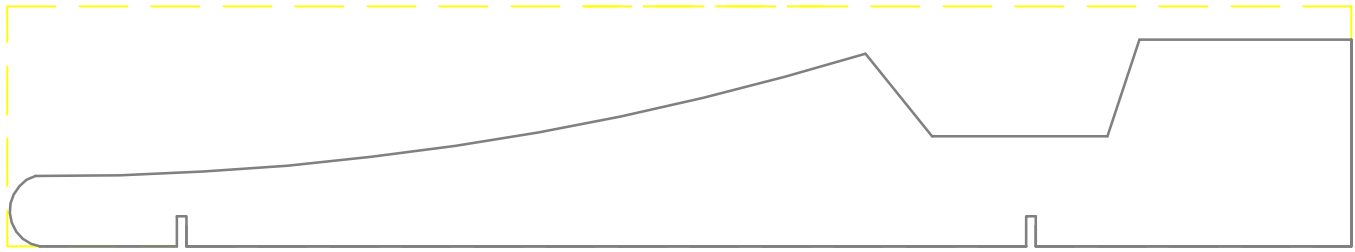
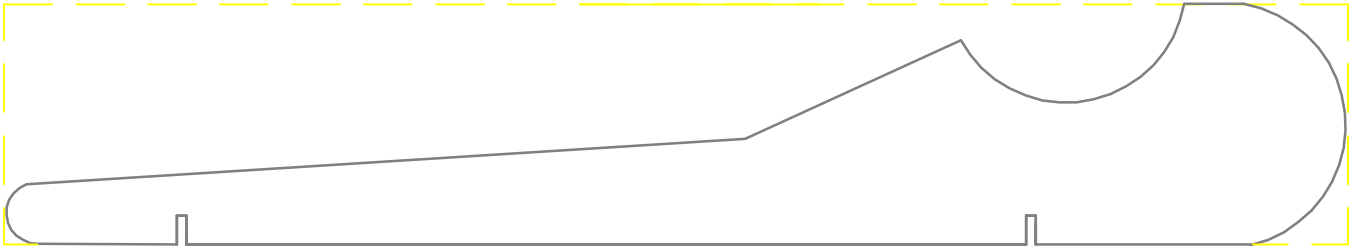

REQUIRES EXTRA HEIGHT

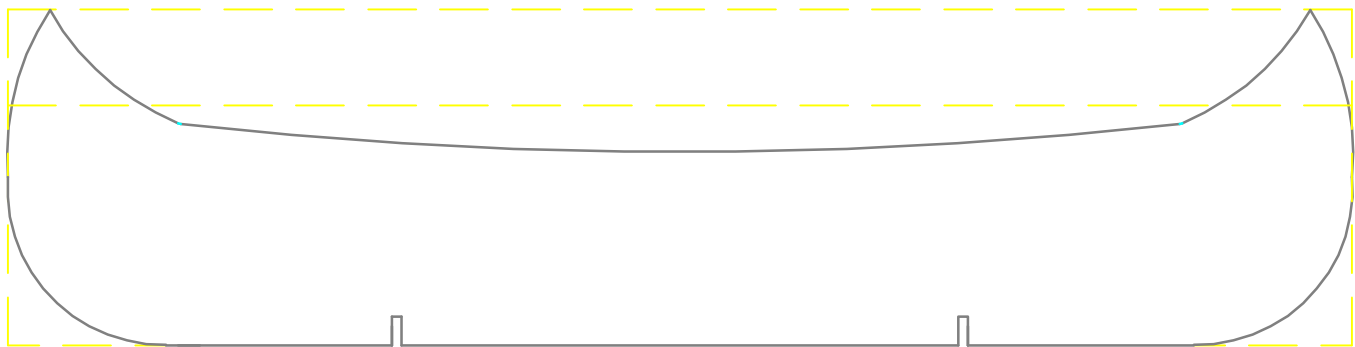

SHORTEN WHEELBASE

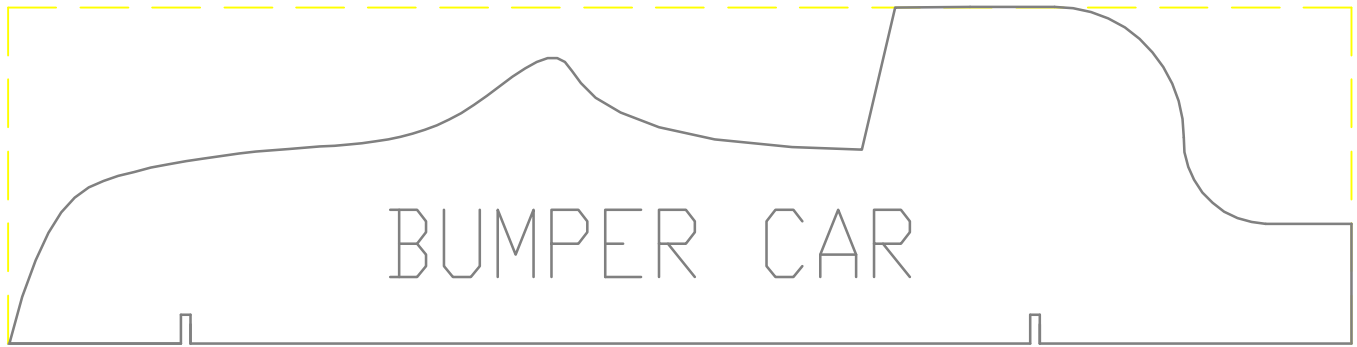

GLUE EXTRA WOOD FOR ADDITIONAL HEIGHT



GLUE ON ROUNDED 1/2" DOWEL

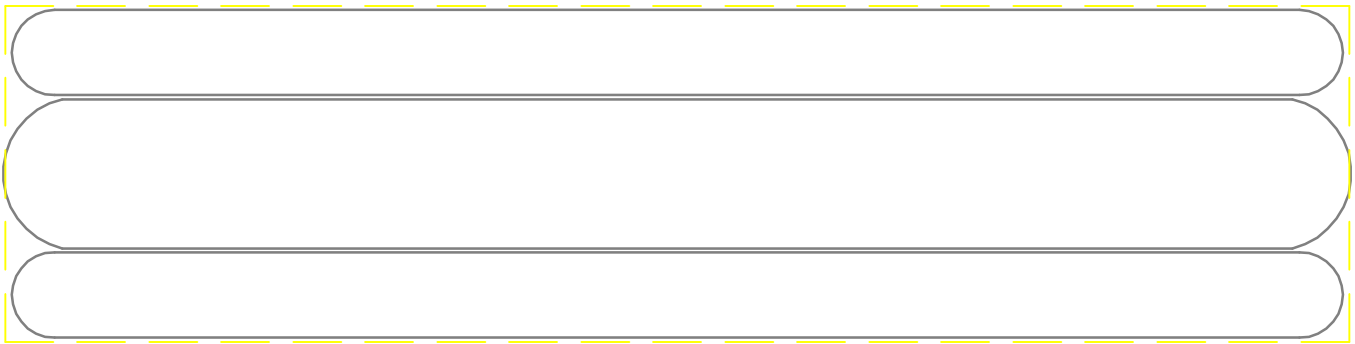
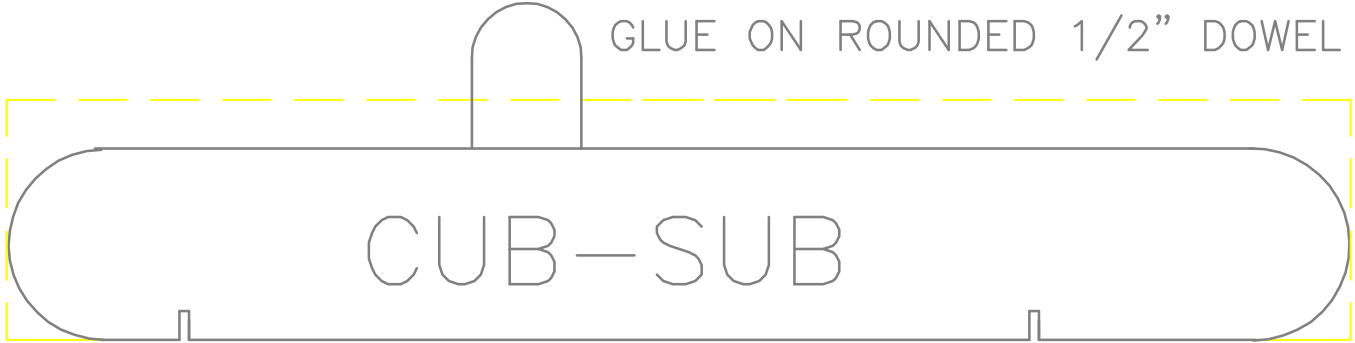

HOTDOGGER TOP VIEW

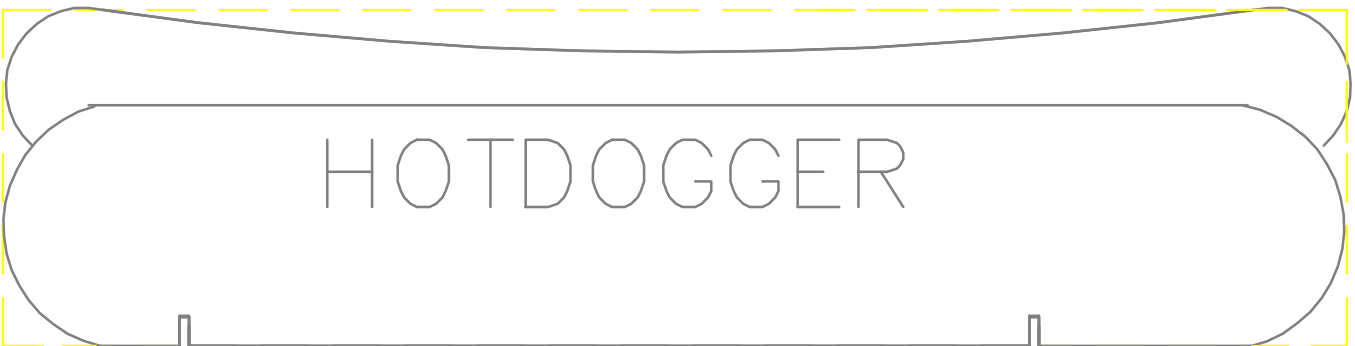

GLUE ADDITIONAL WOOD FOR HEIGHT

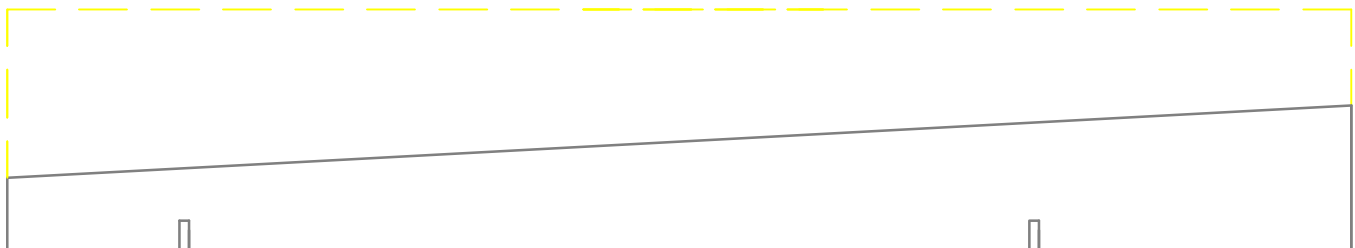

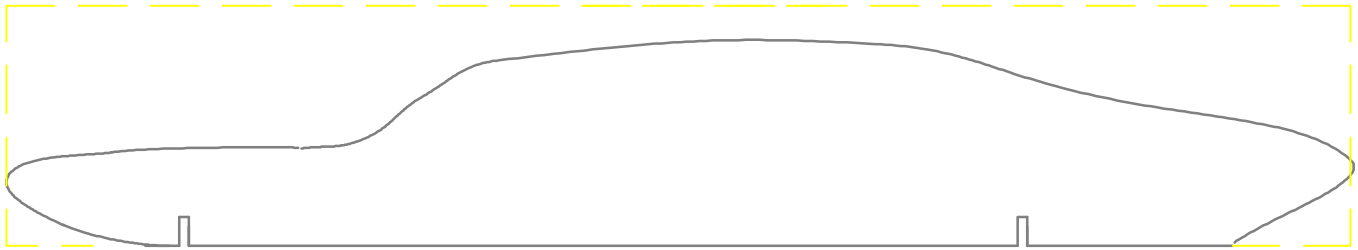
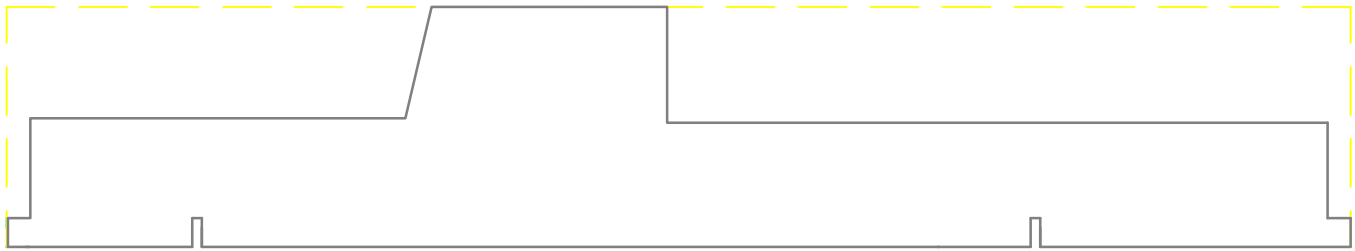
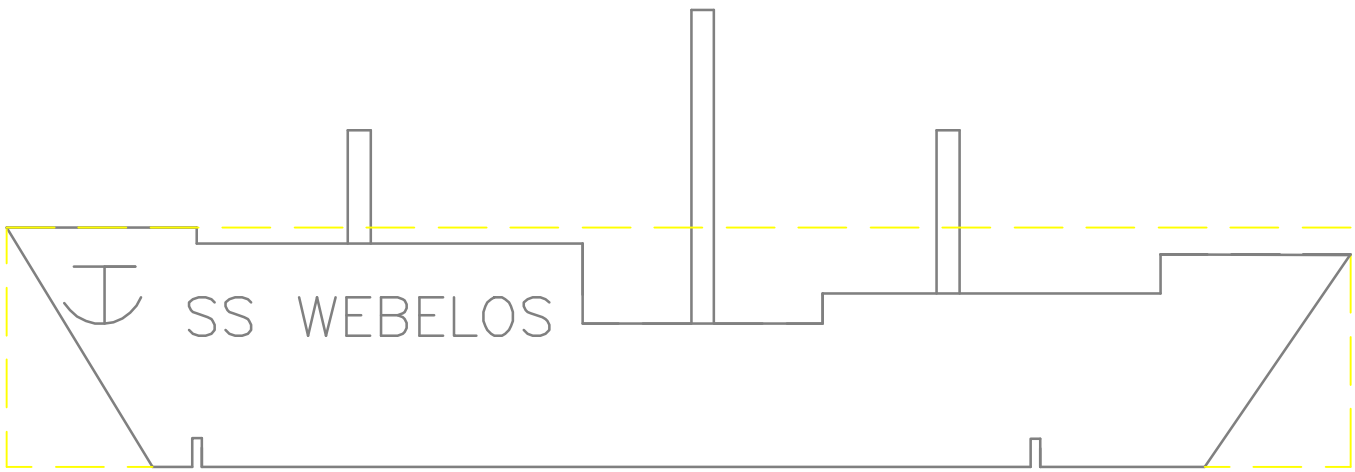
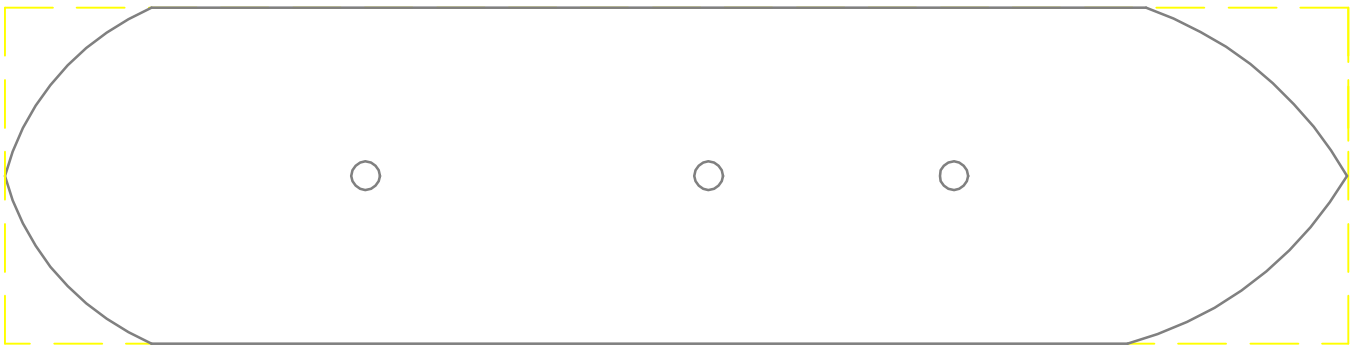

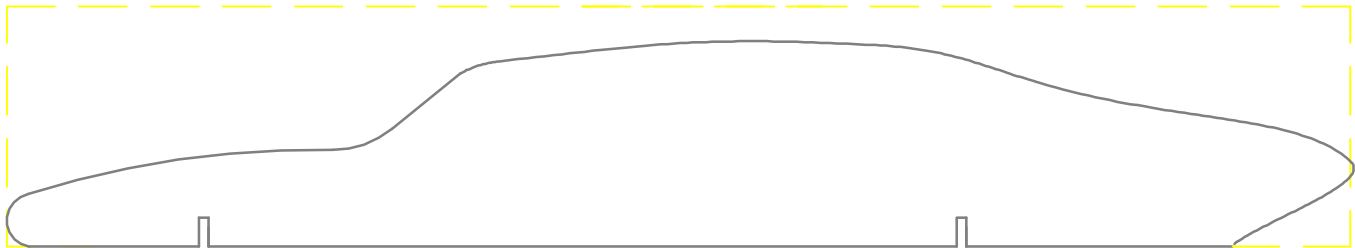
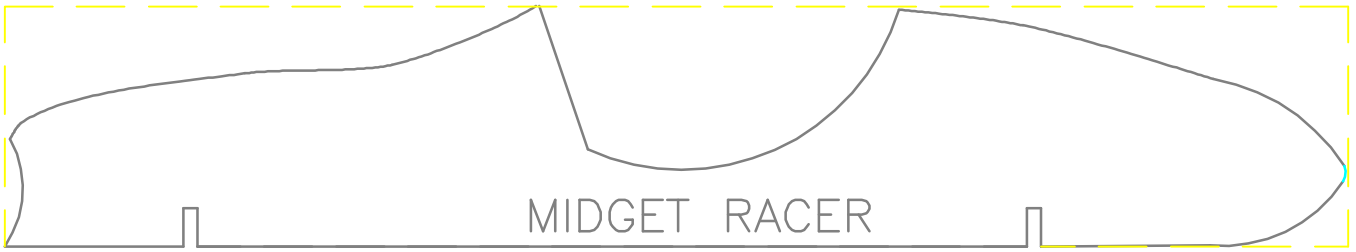
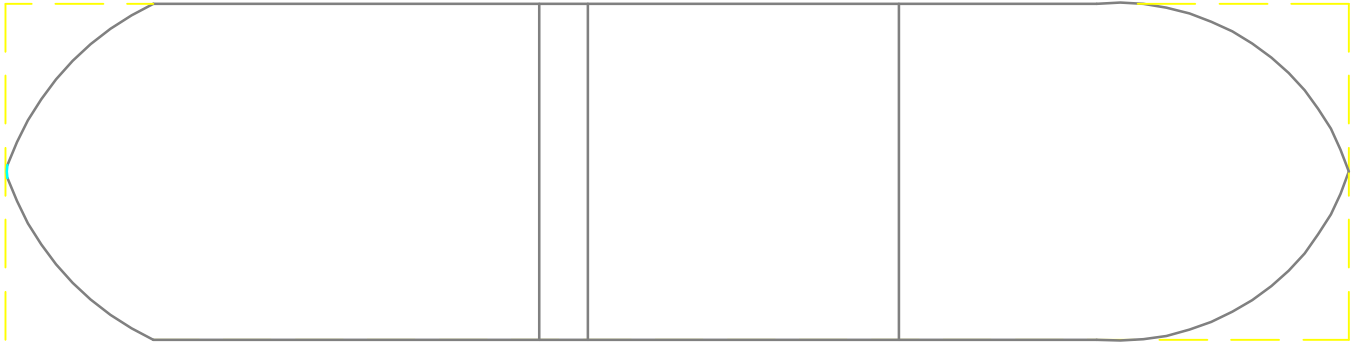

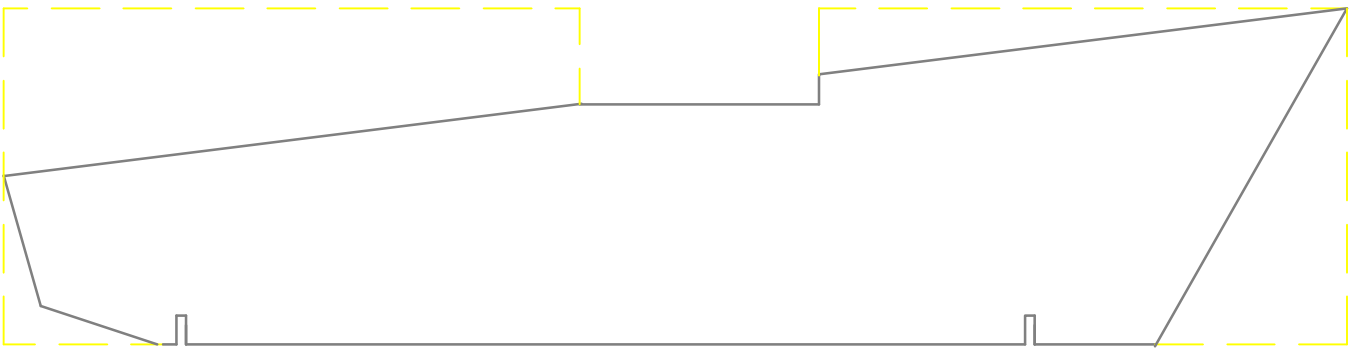
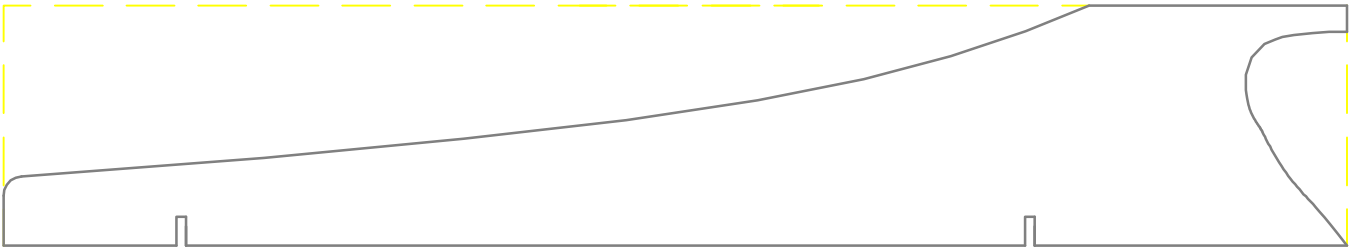
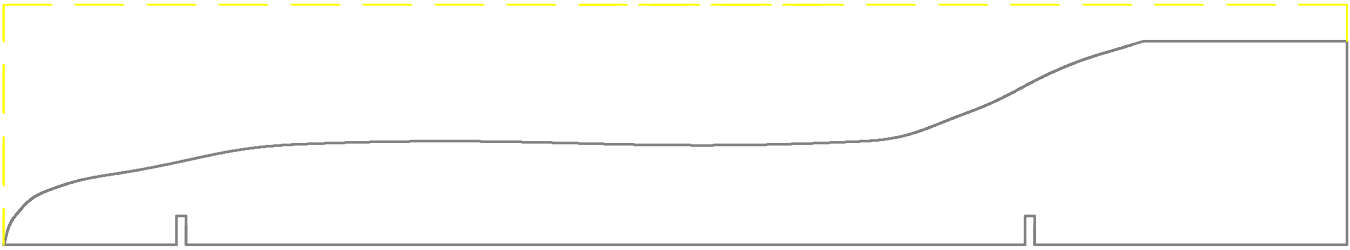

OLD STYLE BLOCK

MINIMOUSE – CUT PROFILE THEN SHAPE BODY

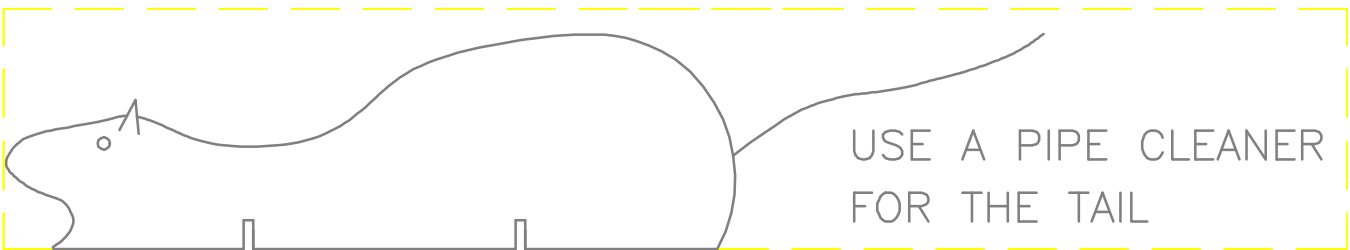

USE A PIPE CLEANER FOR THE TAIL

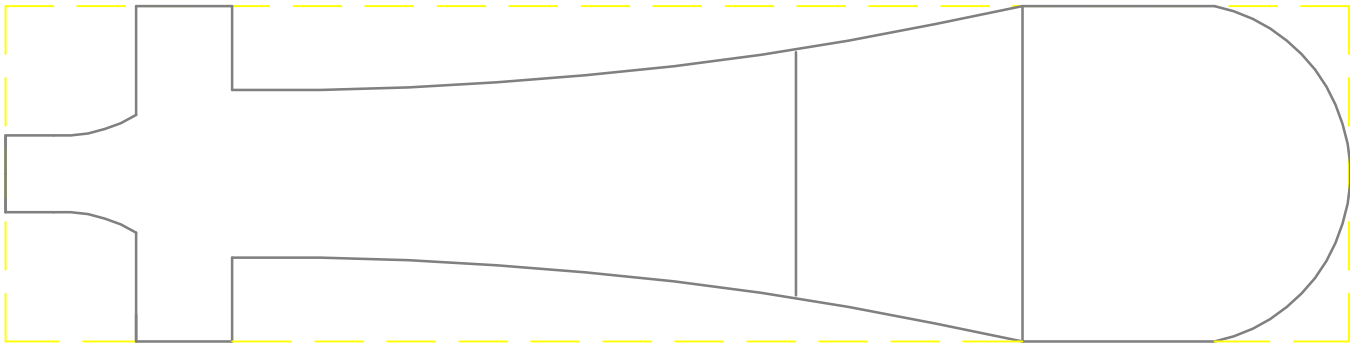
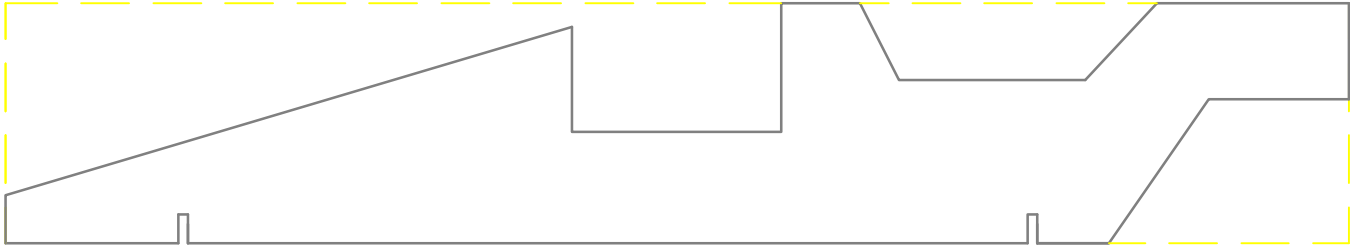

"DRAGSTER TOP VIEW"

"DRAGSTER"

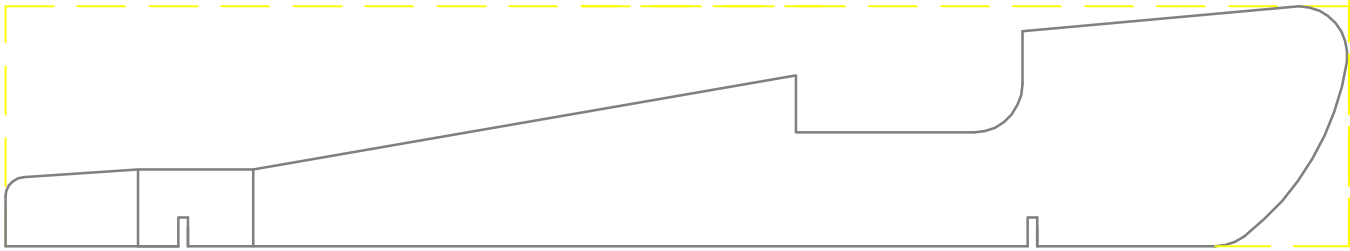

"SLOW SHORT STUFF"



ADD WEIGHT IN 3/8" HOLES

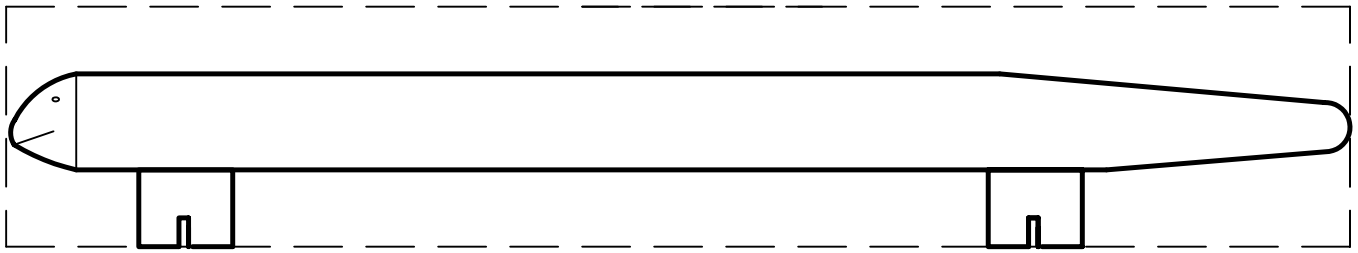

"SNEAKY SNAKE SIDE VIEW"

FRAGILE DESIGN, USE REINFORCEMENT

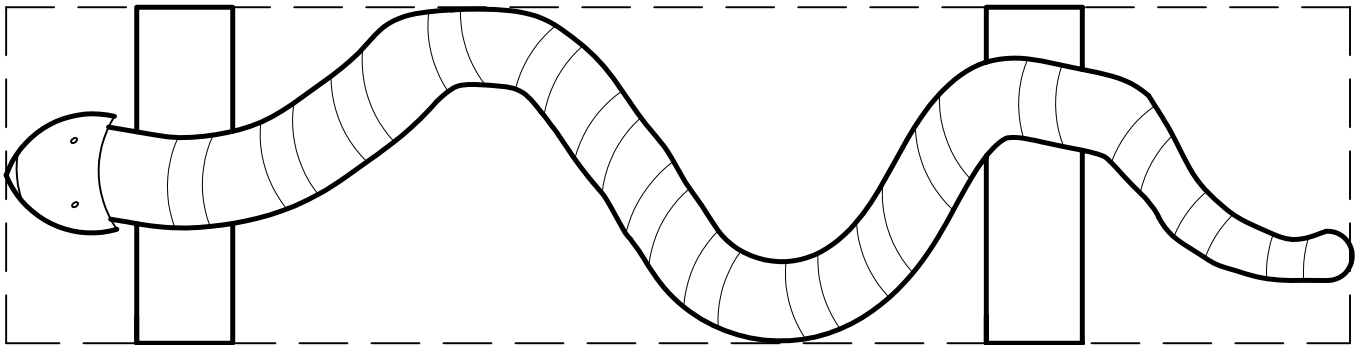

"SNEAKY SNAKE TOP VIEW"

1/8" WOOD DOWELS

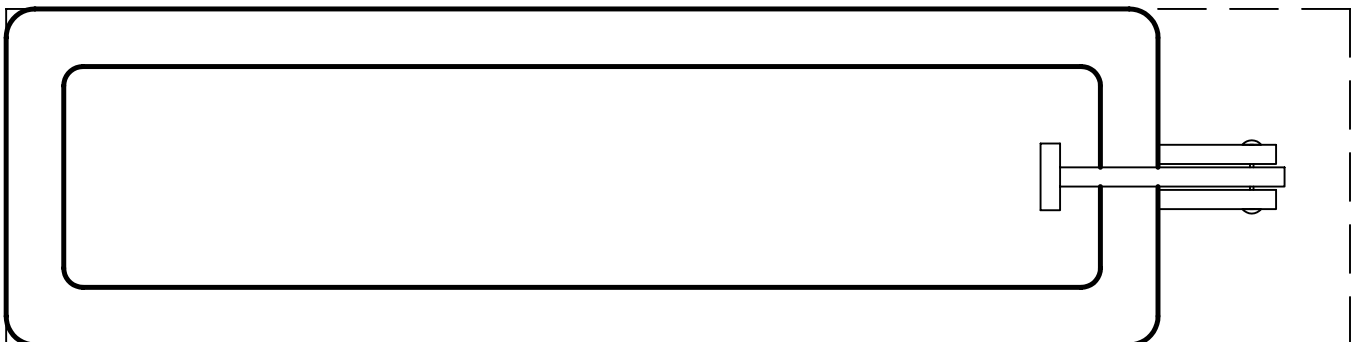

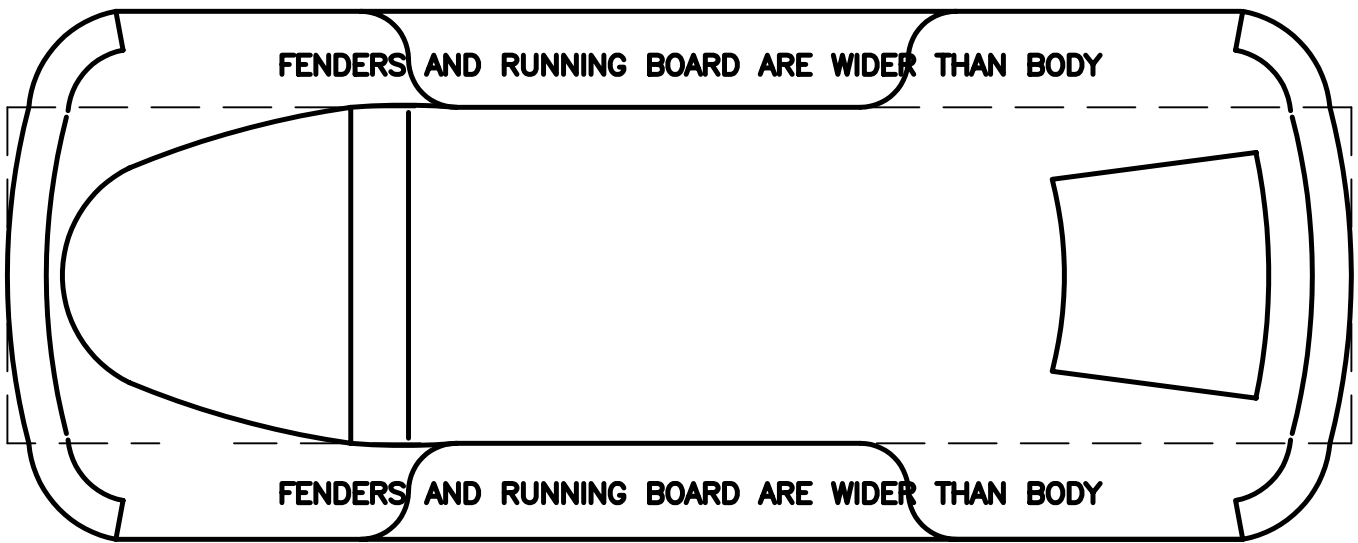

"BUG TOP VIEW"

ADD EXTRA WOOD FOR HEIGHT AND WIDTH

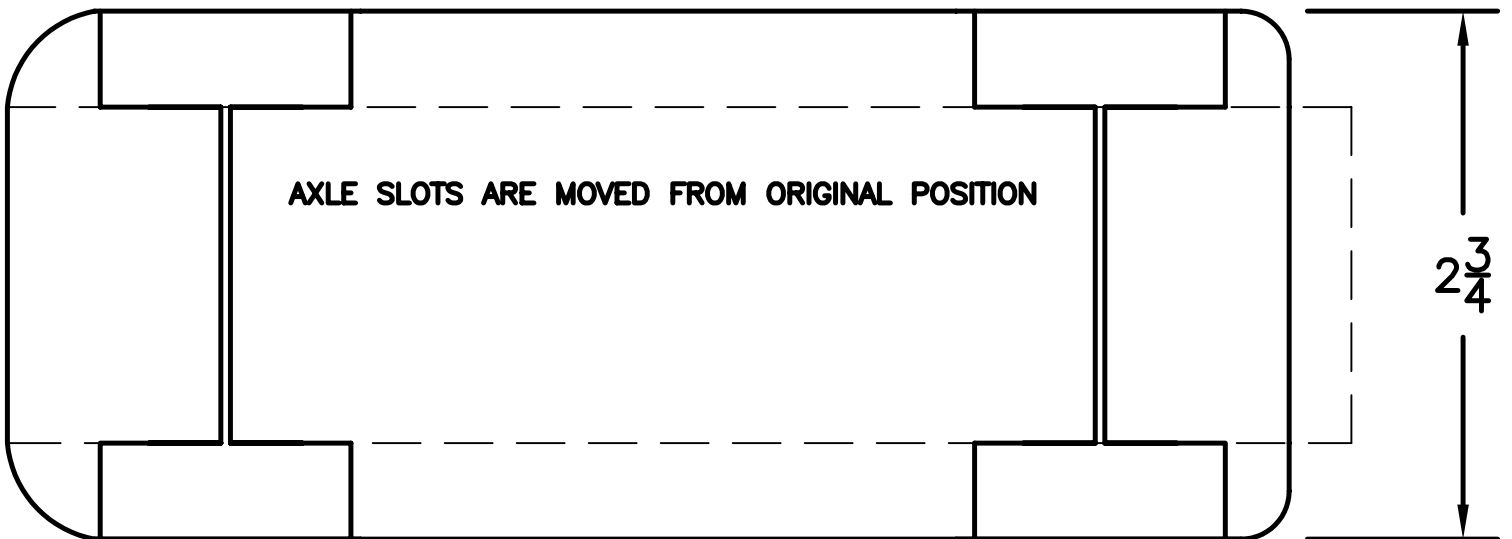
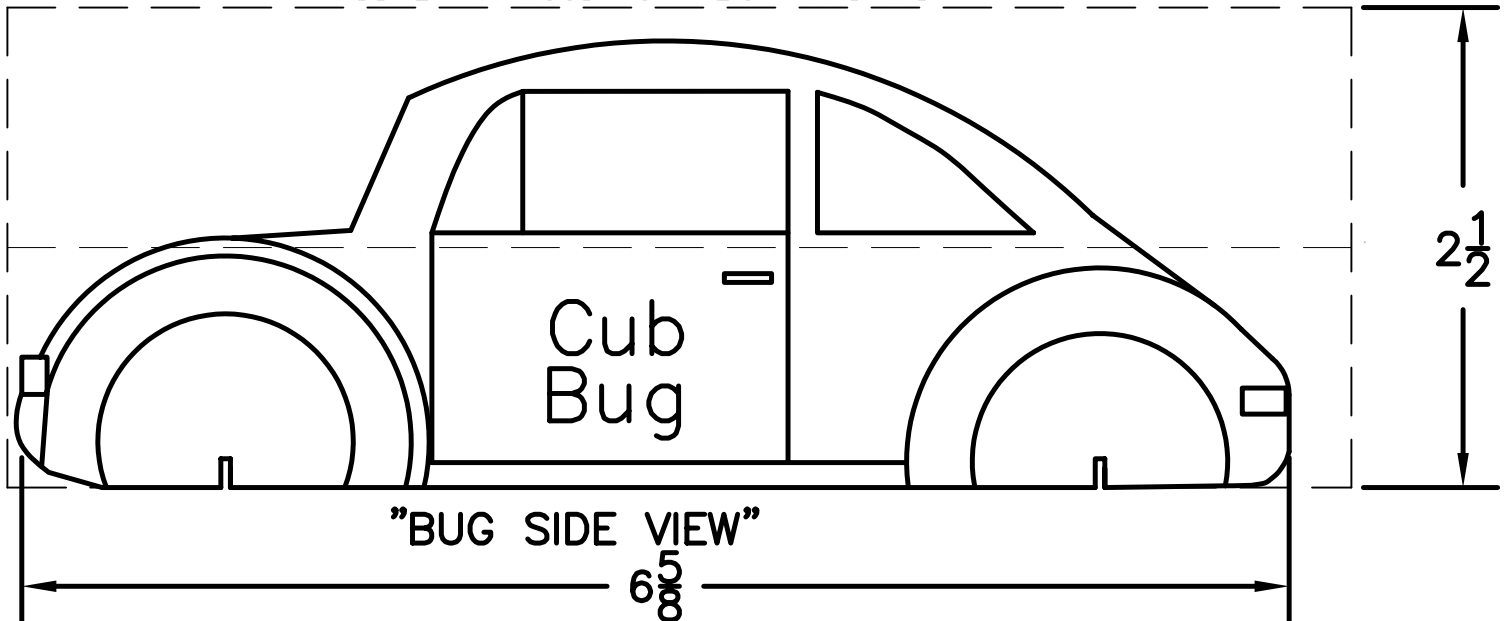

"BUG BOTTOM VIEW"